



CROSSOVER 4500L

**45T capacity class
Boom Truck Crane
Datasheet
imperial**

CROSSOVER 4500L



Features

- ▶ 45 ton rated capacity @ 9 ft from center of rotation
- ▶ 129 ft maximum boom length
- ▶ 136 ft maximum tip height
- ▶ 32/49 ft optional jib
- ▶ 183 ft maximum tip height with 49 ft jib
- ▶ Operator cab – standard
- ▶ Rated capacity indicator with work area definition

WORKS FOR YOU.™

Page:

Key

.....	3
-------	---

Dimensions

Crane Dimensions	4-5
Area of Operation	5
Mounting Specifications	5
Specifications	6
Range Diagram	7

Load Charts



































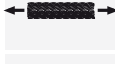

Boom	8-10
Jib	11-12

Technical Description

Boom, Jib and Rotation	13
Hoists and Rope	13-14
Hydraulics	14
Upper Operator Cab	14
Boom Rotation	15
Counterweight	15
Outriggers	15

KEY

CROSSOVER 4500L

	Main boom		Counterweight
	Boom length		Main Hoist
	Tip height		Auxiliary hoist
	Boom with jib		Hoist line speed
	Telescoping mode		Operator aid
	Boom angle		Hydraulics
	Working radius		Heating / Air conditioning
	Main boom with aux head		Outriggers
	Boom head		Rotation / Allowable rotation range
	Hook block		Slewing brake
	Hook to head sheave pin		Boom over the rear
	Rope – Standard / Optional		Boom over the front
	Rope diameter		Area of operation
	Rope length		Gross vehicle weight
	Permissible line pull		Weight on front axle
	Maximum line pull		Weight on pusher axles
	Man basket		Weight on tandem
	Cab		Weight on tag axle

DIMENSIONS

CROSSOVER 4500L

Crane Dimensions

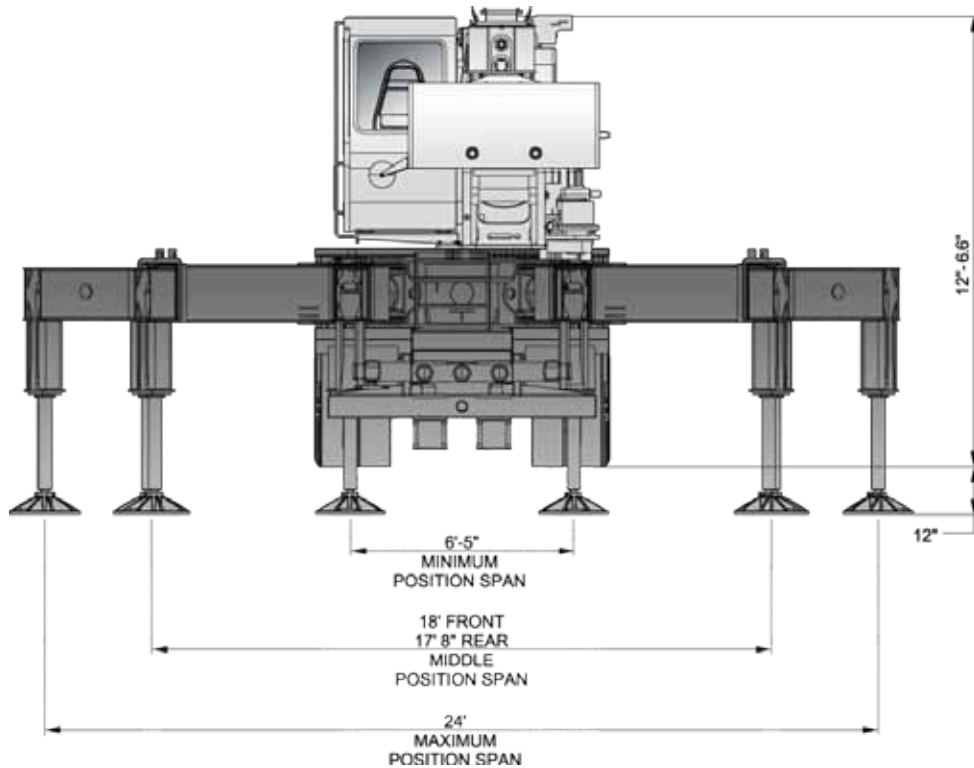
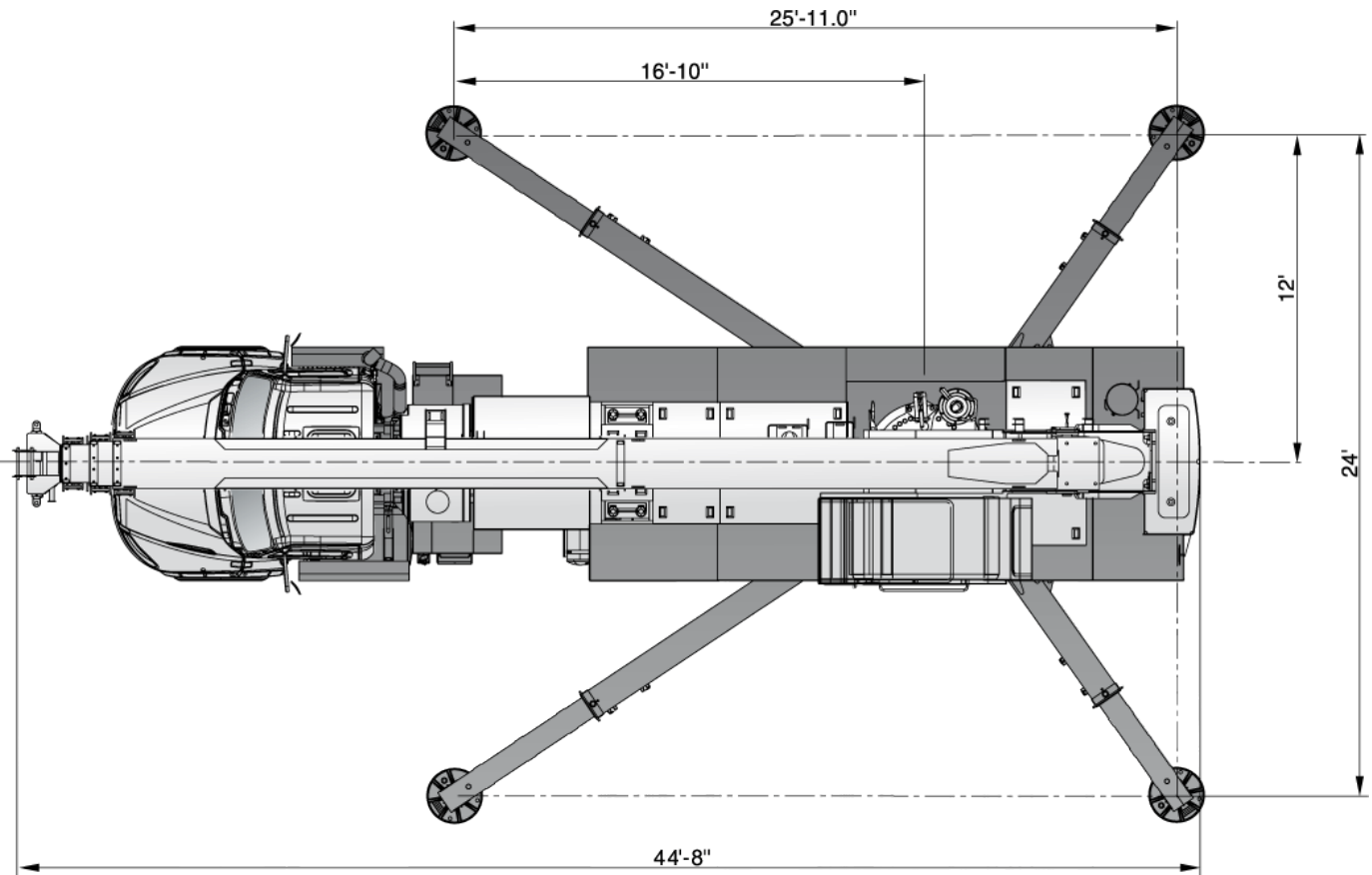

DIMENSIONS

CROSSOVER 4500L

Crane Dimensions

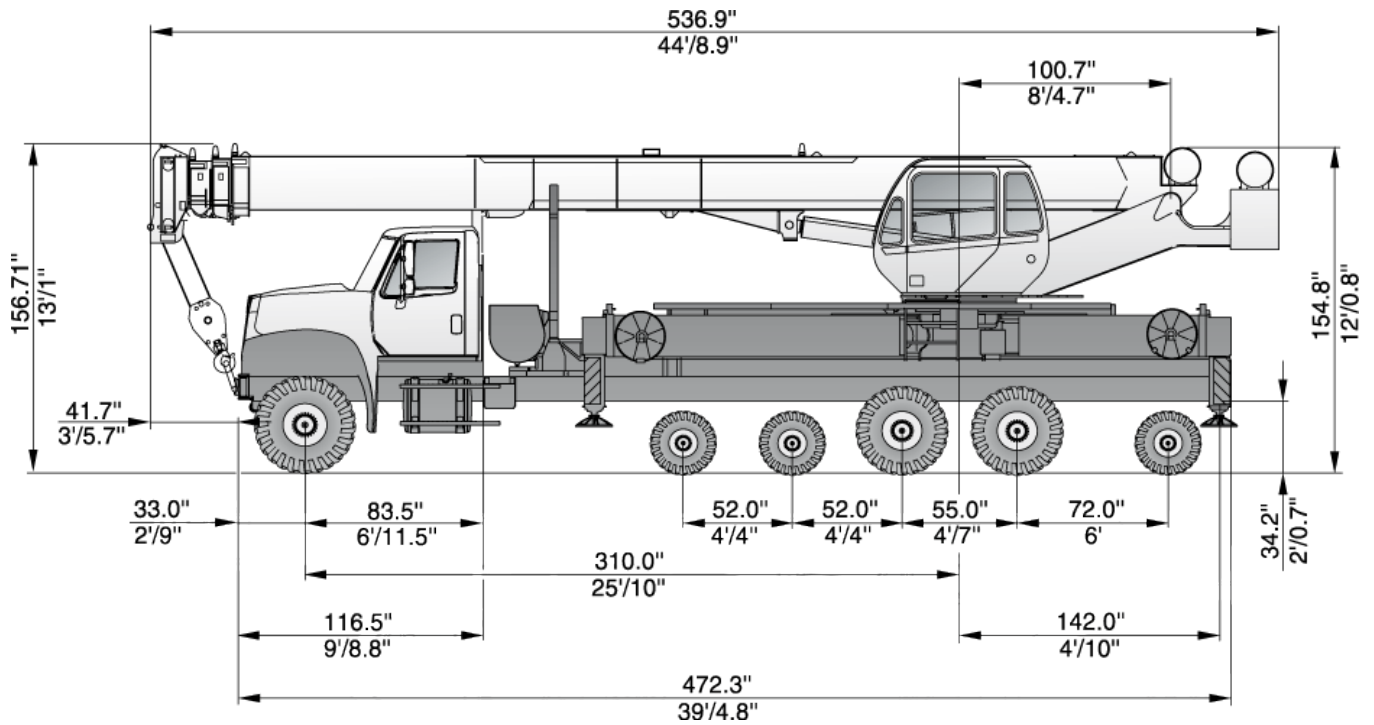

Area of Operation

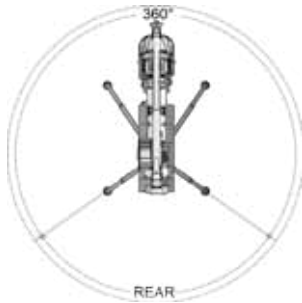

Mounting Specifications

Gross Vehicle Weight Rating	82,000 lb
Front Axle Weight Rating	20,000 lb
Rear Axle Weight Rating	46,000 lb
Pusher (2)	8,000 lb each
Tag	8,000 lb
Wheelbase	291 in
Cab to Axle	225 in
Afterframe	124 in
RBM per Frame Rail	3,300,000 lb-in
Frame Height (Unloaded)	40 ± 3 in

Base machine 69,115 lb
 Crane mounted on 2015 Freightliner 114SD chassis configured per minimum chassis specification.

Estimated minimum chassis weight:

Front axle	9,650 lb*
Tandem axles	10,840 lb*
Total weight	20,490 lb
Maximum weight	22,000 lb

* Minimum bare chassis weight requirements. Ballast is required if below minimum weight.

SPECIFICATIONS

CROSSOVER 4500L

Approximate Crane Weights

Mounted on 2015 Freightliner 114SD with 6 axle configuration						
Configuration:						
	1/4 tank fuel 200 lb operator seated in cab 129 ft boom / no jib 2,000 lb rear counterweight	68,843	14,102	8,000 per axle	32,841	5,900
Options:						
	Full tank of fuel	+ 370	+ 290		+ 72	
	Auxiliary hoist with drum roller and 500 ft wire rope	+ 0	+ 0		+ 0	
	Spin resistant wire rope – main hoist	+ 30	- 9		+ 39	
	Spin resistant wire rope – auxiliary hoist	+ 30	- 13		+ 43	
	32 ft swing-on jib	+ 1368	+ 936		+ 432	
	32 ft to 49 ft extendable swing-on jib	+ 1789	+ 1143		+ 646	
	Auxiliary boom head	+ 105	+ 130		- 25	
	45 USt hook block on bumper 4 sheaves, quick reeving	+ 736	+ 855		- 119	
	7 USt overhaul ball on bumper	+ 340	+ 197		+ 143	
	600 lb capacity man basket on deck	+ 450	+ 160		+ 290	

RANGE DIAGRAM

CROSSOVER 4500L

Outriggers Fully Extended (100%)

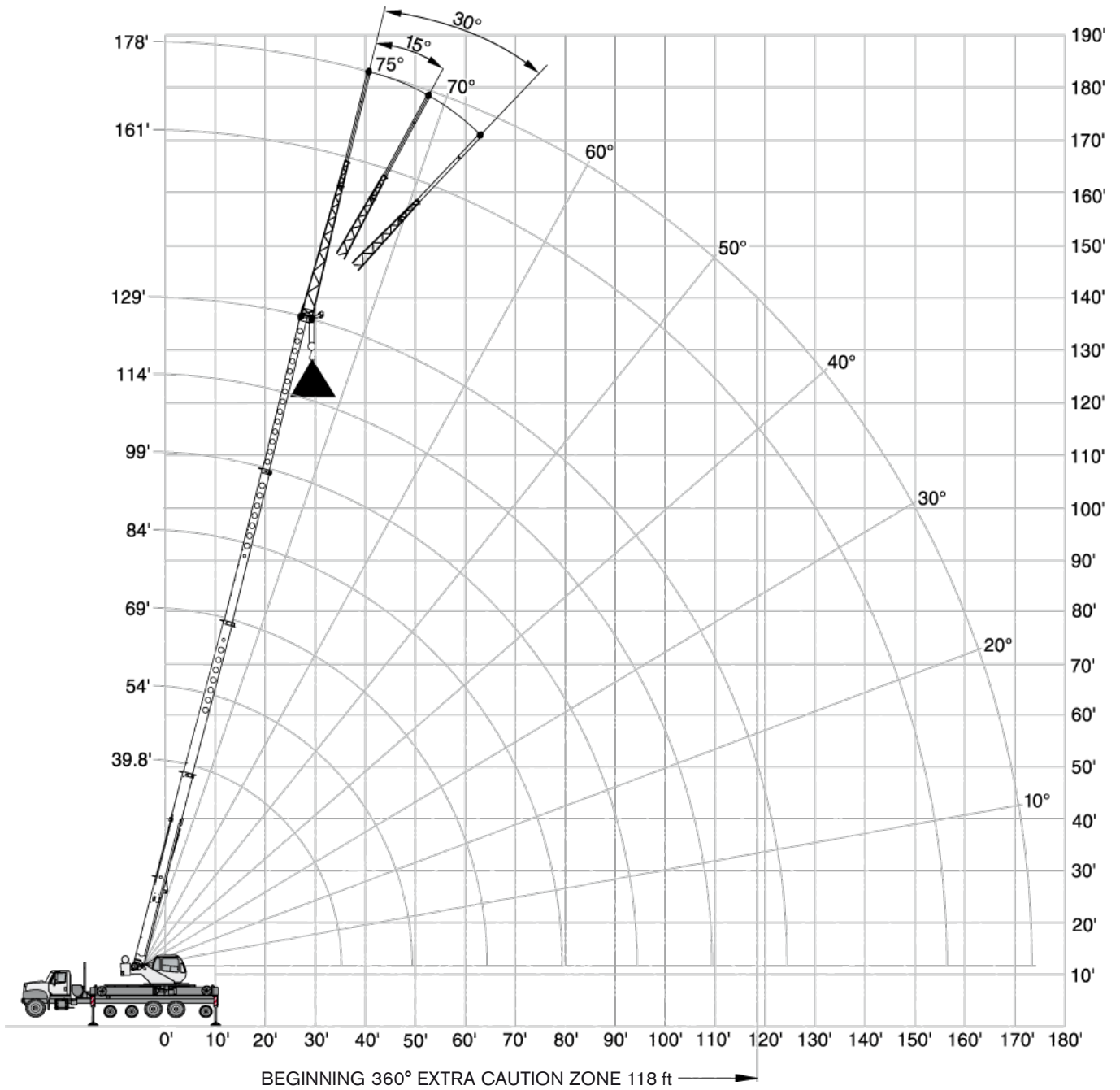
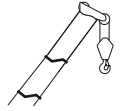

BOOM LOAD CHART

CROSSOVER 4500L

Outriggers Fully Extended (100%)

 2,000 lbs

 (100%)

 over rear

 360°

 39.8 to 129.0 ft

Standard ASME
B30.5

ft	Boom Length														ft	
	39.8 ft		54.0 ft		69.0 ft		84.0 ft		99.0 ft		114.0 ft		129.0 ft			
	lbs	lbs	lbs	lbs	lbs	lbs	lbs	lbs	lbs	lbs	lbs	lbs	lbs	lbs		
9	90,000	90,000														9
10	81,600	81,600	46,500	46,500												10
12	66,500	66,500	46,500	46,500	40,600	40,600										12
15	51,500	51,500	46,500	46,500	37,300	37,300	32,100	32,100								15
20	36,400	36,400	37,800	37,800	33,100	33,100	28,300	28,300	21,700	21,700						20
25	27,300	27,300	28,500	28,500	29,300	29,300	25,100	25,100	18,700	18,700	16,600	16,600				25
30	21,000	21,000	22,500	22,500	23,100	23,100	22,700	22,700	16,100	16,100	14,500	14,500	12,700	12,700		30
35			18,000	18,000	18,800	18,800	19,200	19,200	14,300	14,300	12,700	12,700	11,300	11,300		35
40			14,700	14,700	15,400	15,400	15,900	15,900	12,600	12,600	11,300	11,300	9,900	9,900		40
45			12,000	12,000	12,900	12,900	13,300	13,300	11,400	11,400	10,000	10,000	8,900	8,900		45
50					10,800	10,800	11,300	11,300	10,300	10,300	9,000	9,000	7,800	7,800		50
55					9,100	9,100	9,500	9,500	9,400	9,400	8,100	8,100	7,200	7,200		55
60					7,600	7,600	8,100	8,100	8,400	8,400	7,400	7,400	6,500	6,500		60
65							6,900	6,900	7,200	7,200	6,800	6,800	5,800	5,800		65
70							5,800	5,700	6,200	6,000	6,200	6,200	5,300	5,300		70
75							4,900	4,700	5,300	5,100	5,500	5,200	4,800	4,800		75
80									4,400	4,200	4,700	4,400	4,400	4,400		80
85									3,800	3,500	3,900	3,700	4,000	3,800		85
90									3,100	2,800	3,400	3,100	3,500	3,200		90
95											2,800	2,500	2,900	2,600		95
100											2,200	2,000	2,400	2,100		100
105											1,800	1,600	1,900	1,800		105
110													1,600	1,400		110
115													1,200	1,000		115
120													900	600		120

Notes to lifting capacity

Lifting capacities do not exceed 85% of tipping load. Weight of hook blocks and slings is part of the load, and is to be deducted from the capacity ratings. Consult operation manual for further details.

Note: Data published herein is intended as a guide only and shall not be construed to warrant applicability for lifting purposes. Crane operation is subject to the computer charts and operation manual both supplied with the crane.

BOOM LOAD CHART

CROSSOVER 4500L

Mid Position Outriggers (50%)

 2,000 lbs

 (50%)

 360°

 39.8 to 129.0 ft

Standard ASME
B30.5

	Boom Length							
	39.8 ft	54.0 ft	69.0 ft	84.0 ft	99.0 ft	114.0 ft	129.0 ft	
								
ft	lbs	lbs	lbs	lbs	lbs	lbs	lbs	ft
9								9
10	81,600	46,500						10
12	66,500	46,500	40,600					12
15	51,500	46,500	37,300	32,100				15
20	35,900	37,300	33,100	28,300	21,700			20
25	22,200	23,500	24,300	24,700	18,700	16,600		25
30	14,500	16,100	16,900	17,300	16,100	14,500	12,700	30
35		11,000	11,600	12,000	12,300	12,600	11,300	35
40		7,600	8,300	8,700	9,000	9,200	9,400	40
45		5,200	6,000	6,400	6,700	6,900	7,000	45
50			4,300	4,700	5,000	5,100	5,300	50
55			3,000	3,400	3,700	3,800	3,900	55
60			1,900	2,300	2,600	2,800	2,900	60
65				1,500	1,800	1,900	2,000	65

Notes to lifting capacity

Lifting capacities do not exceed 85% of tipping load. Weight of hook blocks and slings is part of the load, and is to be deducted from the capacity ratings. Consult operation manual for further details.

Note: Data published herein is intended as a guide only and shall not be construed to warrant applicability for lifting purposes. Crane operation is subject to the computer charts and operation manual both supplied with the crane.

BOOM LOAD CHART

CROSSOVER 4500L

Outriggers Fully Retracted (0%)

 2,000 lbs

 (0%)

 over rear

 39.8 to 129.0 ft

Standard ASME
B30.5

	Boom Length							
	39.8 ft	54.0 ft	69.0 ft	84.0 ft	99.0 ft	114.0 ft	129.0 ft	
								
ft	lbs	lbs	lbs	lbs	lbs	lbs	lbs	ft
9	90,000							9
10	81,600	44,100						10
12	66,500	44,100	40,600					12
15	51,500	44,100	37,300	32,100				15
20	36,400	37,800	33,100	28,300	21,700			20
25	27,300	28,500	29,300	25,100	18,700	16,600		25
30	21,000	22,500	23,100	22,700	16,100	14,500	12,700	30
35		18,000	18,800	19,200	14,300	12,700	11,300	35
40		14,700	15,400	15,900	12,600	11,300	9,900	40
45		12,000	12,900	13,300	11,400	10,000	8,900	45
50			10,800	11,300	10,300	9,000	7,800	50
55			9,100	9,500	9,400	8,100	7,200	55
60			7,600	8,100	8,400	7,400	6,500	60
65				6,900	7,300	6,800	5,800	65
70				5,800	6,200	6,200	5,300	70
75				4,900	5,300	5,600	4,800	75
80					4,500	4,800	4,400	80
85					3,800	4,000	4,000	85
90					3,200	3,500	3,700	90
95						2,900	3,100	95
100						2,400	2,500	100
105						1,900	2,100	105
110							1,700	110

Notes to lifting capacity

Lifting capacities do not exceed 85% of tipping load. Weight of hook blocks and slings is part of the load, and is to be deducted from the capacity ratings. Consult operation manual for further details.

Note: Data published herein is intended as a guide only and shall not be construed to warrant applicability for lifting purposes. Crane operation is subject to the computer charts and operation manual both supplied with the crane.

LOAD CHART

CROSSOVER 4500L



With Jib, Outriggers Fully Extended (100%)



 2,000 lbs

 (100%)

 360°

Standard ASME
B30.5

32 ft Offsettable Jib					
0°		15°		30°	
 ft	lbs	 ft	lbs	 ft	lbs
44	5500	53	5000	59	3900
48	5200	57	4800	63	3700
52	5000	61	4600	67	3700
59	4600	67	4300	73	3500
66	4300	73	4200	79	3400
72	3900	79	3700	84	3300
79	3600	85	3300	89	3000
87	2900	92	2700	97	2500
95	2400	99	2200	104	2100
102	1800	106	1600	110	1600
109	1200	112	1100	118	1000
118	600	120	500	126	500

49 ft Offsettable Jib					
0°		15°		30°	
 ft	lbs	 ft	lbs	 ft	lbs
48	3000	59	1900	69	1500
53	2800	64	1900	74	1500
58	2600	69	1800	79	1500
67	2400	77	1700	87	1400
74	2200	85	1600	94	1400
82	2100	92	1600	100	1300
90	1900	99	1500	107	1300
99	1800	108	1500	115	1300
108	1600	117	1400	123	1300
117	1400	125	1300	130	1200
125	900	132	800	136	800

Notes to lifting capacity

Lifting capacities do not exceed 85% of tipping load. Weight of hook blocks and slings is part of the load, and is to be deducted from the capacity ratings. Consult operation manual for further details.

Note: Data published herein is intended as a guide only and shall not be construed to warrant applicability for lifting purposes. Crane operation is subject to the computer charts and operation manual both supplied with the crane.



LOAD CHART



CROSSOVER 4500L

With Jib, Mid Position Outriggers (50%)



Standard ASME
B30.5

32 ft Offsettable Jib					
0°		15°		30°	
 ft	lbs	 ft	lbs	 ft	lbs
44	5500	53	5000	59	3900
48	5200	57	4800	63	3700
52	4600	61	3900	67	3500
59	3300	67	2800	73	2500
66	2200	73	1900	79	1600
72	1200	79	1000	84	900











49 ft Offsettable Jib					
0°		15°		30°	
 ft	lbs	 ft	lbs	 ft	lbs
48	3000	59	1900	69	1500
53	2800	64	1800	74	1500
58	2600	69	1700	79	1500
67	2400	77	1500	87	1400
74	1800	85	1200	94	1400
82	1100				

Notes to lifting capacity

Lifting capacities do not exceed 85% of tipping load. Weight of hook blocks and slings is part of the load, and is to be deducted from the capacity ratings. Consult operation manual for further details.

Note: Data published herein is intended as a guide only and shall not be construed to warrant applicability for lifting purposes. Crane operation is subject to the computer charts and operation manual both supplied with the crane.

Boom, Jib and Rotation

	Four-section full power fully synchronized telescopic boom	
	Boom length	Retracted: 39.8 ft Extended: 129 ft
	Boom maximum tip height	136 ft
	Boom elevation angle range (min. / max.)	-3° / 77.5°
	Boom head	quick reeving
	360° continuous rotation	
	Load moment / Rated capacity indicator with work area definition ATB system	
Optional		
	Swing-On Jib – fixed length – can be offset to 0°, 15° or 30° Maximum tip height with fixed jib	32 ft 167 ft
	Swing-On Jib – adjustable length – can be offset to 0°, 15° or 30° Maximum tip height with extended jib	32 ft / 49 ft 183 ft
	4 metallic sheaves Quick reeving design	45 T
	Top swivel ball with hook and latch	7 T
	Two person man basket	

Hoists and Rope



	Two speeds First layer (no load speed) Fifth layer (no load speed)	Low Speed: 167 ft/min 242 ft/min	High Speed: 335 ft/min 487 ft/min
	First layer Fifth layer	Low Speed: 15,639 lb 10,827 lb	High Speed: 7,298 lb 5,052 lb
	Permissible line pull	9,000 lb	
		6 x 19 IWRC XIPS	
	Maximum useable	490 ft	
		0.625 in	

		Optional	
	Two speeds First layer (no load speed) Fifth layer (no load speed)	Low Speed: 167 ft/min 242 ft/min	High Speed: 335 ft/min 487 ft/min
	First layer Fifth layer	Low Speed: 15,639 lb 10,827 lb	High Speed: 7,298 lb 5,052 lb
	Permissible line pull	9,000 lb	
		6 x 19 IWRC XIPS	
		0.625 in	

Hydraulics

	Triple pump: Hoist Boom lift / telescope Outrigger / swing	60.3 gal/min @ 3,500 psi 45.1 gal/min @ 3,500 psi 22 gal/min @ 2,500 psi
	Single pump: Power steering	8 gal/min @ 2,000 psi
	Full flow filtration with bypass protection: Suction Return	250 micron screen 5 micron filter
	Pressurized tank with sight level gauge	91 gal

Upper Operator Cab

	Upper cab Sliding door on left side Sliding window on the right side Tilting, tinted glass skylight Removable front windshield Six-way adjustable seat with armrest dual-axis electro-proportional joysticks Joystick control for hoist(s), swing and boom elevation Foot pedals for swing brake, boom telescope and engine rpm Hand control for engine rpm
	Optional features for upper cab Air conditioning – hydraulically powered Heater and air conditioning package – hydraulically powered Liquid propane (LP) cab heater Single-axis armrest mounted controls Work lights
	Rated capacity indicator with pictograph display of boom radius, boom angle, boom length, allowable load, actual load and % of allowable load Settable alarms for swing angle, boom length, boom angle, tip height and work area exclusion zone

Boom Rotation



Foot pedal actuated multi-disc brake and air actuated 360° house lock



Hydraulic driven double planetary reduction gear drive

2.8 rev/min

Counterweight



Main counterweight, non removable, bolted to upper crane structure

2,000 lb counterweight package

Outriggers



X-pattern

MAX Front: Swing, Out and Down
To outer edge of pad

26 ft

Rear: Swing, Out and Down
To outer edge of pad

26 ft

MID Front: Swing, Out and Down
Rear: Swing, Out and Down

20 ft

19.5 ft

Effective Date: January 2014.

Product specifications and prices are subject to change without notice or obligation. The photographs and/or drawings in this document are for illustrative purposes only. Refer to the appropriate Operator's Manual for instructions on the proper use of this equipment. Failure to follow the appropriate Operator's Manual when using our equipment or to otherwise act irresponsibly may result in serious injury or death. The only warranty applicable to our equipment is the standard written warranty applicable to the particular product and sale and Terex makes no other warranty, express or implied. Products and services listed may be trademarks, service marks or trade-names of Terex Corporation and/or its subsidiaries in the USA and other countries. All rights are reserved. Terex® is a registered trademark of Terex Corporation in the USA and many other countries.

Copyright Terex Cranes 2014

Terex Cranes, Global Marketing, Dinglerstraße 24, 66482 Zweibrücken, Germany
Tel. +49 (0) 6332 830, Email: info.cranes@terex.com, www.terexcranes.com



www.terexcranes.com

Brochure Reference: TC-DS-I-E-Crossover4500L-01/14



TEREX®

WORKS FOR YOU.™